

TOP FILTERFANS - TEPE FANI

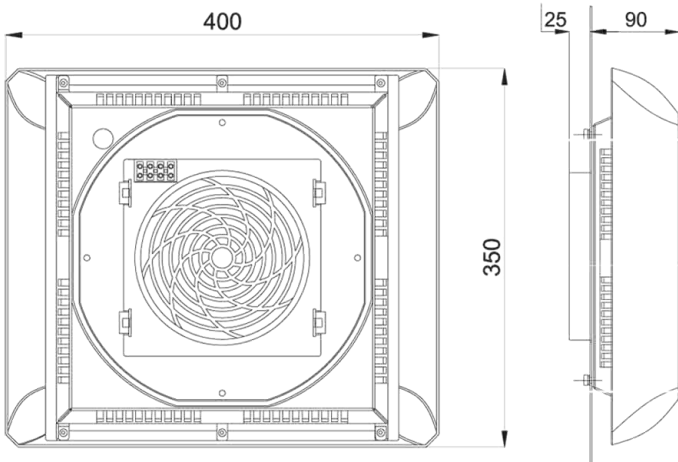

SPECIFICATIONS	ÖZELLİKLER	UNIT	QFF 6000
Airflow rate without filter	Hava Debisi Fitresiz	m ³ / h	950
Airflow rate with filter	Hava Debisi Fitreli	m ³ / h	850
Rated Voltage	Besleme Voltajı	V/Hz	230 / 50
Nominal Current	Nominal Akım	A	0.35
Power Consumption	Enerji Tüketimi	W	90
Overcurrent Protection	Aşırı Akım Koruma	-	Thermal Protection / Sıcaklık Koruma
Electric Connection	Elektrik Bağlantısı	-	3-pole terminal 2,5 mm ² / klemens
Duty Cycle	Devrede Kalma	%	100
Operating Temperature	Çalışma Sıcaklığı	°C	-10 +70
Protection Degree	Koruma Sınıfı Pano Tarafı	-	IP 33
Noise Level	Gürültü Seviyesi	dB	65
Bearing	Motor Yataklaması	-	Ball Bearing / Rulman
Flow Direction	Hava Akış Yönü	-	Outside in / Dışarıdan içeriye
Material	Malzeme	-	ABS UL 94V-0
Color	Renk	-	RAL7032 - RAL7035 - RAL9001 - Silver
Gasket	Sızdırmazlık Contası	-	Polyurethane / Poliüretan
Weight	Ağırlık (paketlenmiş)	kg	3.2
Dimensions	Ölçüler	mm	400x350x102
Package Dimensions	Paket Ölçüleri	mm	440x360x130
Mounting	Montaj	-	Fast Clip-on / Kolay Montaj Klips
Confirmity / Approvals	Sertifika	-	CE



POLYURETHANE GASKET



ABS UL 94V-0

